

EQO *fluids*



Rozvody stlačeného vzduchu a jiných médií EQOfuids

KATALOG

CZ

L1.2.0



EQO*h2o* **EQO***nitro* **EQO***vac* **EQO***oilHP* **EQO***fire* **EQO***h2oHP* **EQO***air* **EQO***airHP*







Srpen 2017

Obsah

EQOfluids	Technická specifikace, certifikace	2 - 4
EQOair	Fitinky a trubky pro stlačený vzduch do 16 bar	6 - 8
EQOh2o	Fitinky a trubky pro dopravu vody do 16 bar	9 - 11
EQOnitro	Fitinky a trubky pro dusík do 16 bar	9 - 11
EQOfire	Fitinky a trubky pro požární vodu do 16 bar	12 - 14
EQOvac	Fitinky a trubky pro vakuum < 10mBar	15 - 17
EQOairHP	Fitinky a trubky pro stlačený vzduch do 70 bar	20 - 22
EQOilHP	Fitinky a trubky pro dopravu oleje do 70 bar	23 - 24
EQOh2oHP	Fitinky a trubky pro dopravu vody do 200 bar	25 - 26
EQOfluids	Příslušenství	28 - 35
EQOfluids	Bezpečnostní rychlospojky	36 - 37
EQOfluids	Nářadí a podpora prodeje	38

Certifikáty a prohlášení:

ISO 9001:2008 SGS CERTIFICATE	ES13/13865	
TSSA ONTARIO CNR N°AO16981.56	N°AO16981.56	
QUEBEC CNR N°OA16981.56	N°OA16981.56	
CERTIFIKÁT KVALITY POVRCHU	--	
POŽÁRNÍ ODOLNOST DLE EN1350-1	B s1 d0	 RINA
TLAKOVÝ / TEPLTNÍ TEST	- 15°C / 240,5 Bar +140°C / 199,0 Bar	
ZÁRUKA	10 YEARS	EQOfluids
PROHLÁŠENÍ O SHODĚ ASME	(2014/68/UE) ASME B31.3 - B31.9	EQOfluids

Technická specifikace:

	EQOair	EQOh2o EQOnitro	EQOfire	EQOvac	EQOairHP	EQOoilHP	EQOh2oHP
Standardní barva	RAL 5012	RAL 6018	RAL 3000	RAL 7046	RAL 5017	RAL 8007	RAL 6032
Maximální provozní tlak	16 Bar	16 Bar	16 Bar	<10 MBar	70 Bar	70 Bar	200 Bar
Výrobní test po dobu 1 hodiny při 20°C	24 Bar	24 Bar	24 Bar	24 Bar	105 Bar	105 Bar	300 Bar
Kvalitativní test po dobu 1 hodiny při 20°C	64 Bar	64 Bar	64 Bar	64 Bar	280 Bar	280 Bar	400 Bar
Testovaný podíl produkce	1%	1%	1%	1%	100%	100%	100%
Materiál o-kroužku	NBR 65/75 S.A.	EPDM65/75S.A.	EPDM65/75S.A.	NBR 65/75 S.A.	NBR 65/75 S.A.	FPM 65/75 S.A.	EPDM65/75S.A.
Teplotní omezení	-20°C a 100°C	-50°C a 150°C	-50°C a 150°C	-20°C a 100°C	-20°C a 100°C	-20°C a 100°C	-50°C a 150°C
Mechanická odolnost trubek	Podle EN-755-2/2008 standardů						
Materiál trubek	Hliníková slitina EN AW 6060 - T5 podle EN 755-2/2008						
Tloušťka trubek	D20-S1,0 - D25-S1,1 - D32-S1,2 - D40-S1,3 - D50-S1,4 - D63-S1,8 - D90-S2,0 - D110-S3,0 - D140-S3,8 - D160-S4,3 Tolerance délky trubek +0 -0,1%						
Materiál hliníkových fitinek	Hliníková slitina EN Aw 6061 T6 / ENAB 42000						
Materiál svěrného kroužku	AISI 304 Nerezová ocel						
Vnitřní závity v souladu s	BSPT - British Standard Pipe Taper ora ISO 7-1 - NPT- National Pipe Thread Taper- ANSI B1.20.1						
Povrchová úprava trubek	Prášková barva						
EQOfire	Fitinky pro požární vodu jsou dodávány bez plastového identifikačního kroužku						

Limity pro charakteristiku dopravované vody jsou umístěny na straně 4



Instrukce pro objednání:

Při objednávání uveďte úplné objednávací číslo požadované položky; zabráníte tím chybám či nedorozměním.
V případě pochybností nás neváhejte kontaktovat. Poskytneme veškeré informace ohledně jednotlivých dílů a jejich použití.

Čísla dílů zbarvená do šeda prozatím nejsou skladem.

Limity pro charakteristiku dopravované vody:

Technická specifikace	EQO<i>h2o</i>	EQO<i>fire</i>	EQO<i>h2oHP</i>
Standardní barva	RAL 5012	RAL 3000	RAL 6032
Materiál O-kroužku		EPDM65/75S.A.	
Teplotní omezení		-50°C a 150°C	
Limit PH		PH: 6,5 ÷ 8	
Limit Chlóru		CL: < 0,25ppm	



EQO *air* - EQO *h2o* EQO *nitro* - EQO *fire* - EQO *vac*

Fitinky a trubky pro dopravu stlačeného vzduchu od průměru D20 do D160 mm- Pracovní tlak 16 bar

Fittings and Pipes able to Transport Pressurised Air from D20 up to D160- Working Pressure 16Bar

Fitinky a trubky pro dopravu dusíku a vody od průměru D20 do D160 mm- Pracovní tlak 16 bar

Fittings and Pipes able to transport Water and Nitrogen from D20 up to D160- Working Pressure 16Bars

Fitinky a trubky pro dopravu požární vody od průměru D20 do D160 mm- Pracovní tlak 16 bar

Fittings and Pipes able to transport Water in Anti Fire Plants from D20 up to D160- Working Pressure 16Bars

Fitinky a trubky pro dopravu vakua od průměru D20 do D160 mm – pracovní tlak <-10MBar

Fittings and Pipes able to transport Vacuum from D20 up to D160- Working Pressure <-10MBar



PN16

Hliníková trubka	Objednáací číslo	Ø	Délka	PN		Počet trubek v balení	Počet metrů v balení
	82.900.020.106	20	6 M.	16 bar		17	102
	82.900.025.106	25	6 M.	16 bar		23	138
	82.900.032.106	32	6 M.	16 bar		14	84
	82.900.040.106	40	6 M.	16 bar		8	48
	82.900.050.106	50	6 M.	16 bar		5	30
	82.900.063.106	63	6 M.	16 bar		4	24
	82.900.090.106	90	6 M.	16 bar		28	144
	82.900.110.106	110	6 M.	16 bar		15	90
	82.900.160.106	160	6 M.	16 bar		6	36

Spojka	Objednáací číslo	Ø	Typ	PN		Balení A kusy	Balení B kusy
 A  B	82.010.020	20	A	16 bar		50	400
	82.010.025	25	A	16 bar		24	192
	82.010.032	32	A	16 bar		17	136
	82.010.040	40	A	16 bar		-	48
	82.010.050	50	A	16 bar		-	30
	82.010.063	63	A	16 bar		-	24
	82.010.090	90	A	16 bar		-	8
	82.010.110	110	B	16 bar		-	8
	82.010.160	160	B	16 bar		-	2

Posuvná spojka	Objednáací číslo	Ø	Typ	PN		Balení A kusy	Balení B kusy
	82.012.020	20	A	16 bar		50	400
	82.012.025	25	A	16 bar		24	192
	82.012.032	32	A	16 bar		17	136
	82.012.040	40	A	16 bar		-	48
	82.012.050	50	A	16 bar		-	30
	82.012.063	63	A	16 bar		-	24
	82.012.090	90	A	16 bar		-	8

Spojka s vnitřním závitem	Objednáací číslo	Ø	Typ	PN		Balení A kusy	Balení B kusy
	82.030.020.048	20x1/2"	A	16 bar		75	600
	82.030.025.068	25x3/4"	A	16 bar		60	480
	82.030.032.088	32x1"	A	16 bar		32	256
	82.030.040.108	40x1.1/4"	A	16 bar		-	48
	82.030.050.128	50x1.1/2"	A	16 bar		-	40
	82.030.063.168	63x2"	A	16 bar		-	24

Spojka s vnějším závitem	Objednáací číslo	Ø	Typ	PN		Balení A kusy	Balení B kusy
	82.020.020.048	20x1/2"	A	16 bar		75	600
	82.020.020.068	20x3/4"	A	16 bar		75	600
	82.020.025.068	25x3/4"	A	16 bar		60	480
	82.020.025.088	25x1"	A	16 bar		42	336
	82.020.032.088	32x1"	A	16 bar		32	256
	82.020.032.108	32x1.1/4"	A	16 bar		24	192
	82.020.040.108	40x1.1/4"	A	16 bar		-	48
	82.020.040.128	40x1.1/2"	A	16 bar		-	48
	82.020.050.128	50x1.1/2"	A	16 bar		-	40
	82.020.050.168	50x2"	A	16 bar		-	40
	82.020.063.168	63x2"	A	16 bar		-	24
	82.020.063.208	63x2.1/2"	A	16 bar		-	24
	82.020.090.248	90x3"	A	16 bar		-	12

T-kus	Objednáací číslo	Ø	Typ	PN		Balení A kusy	Balení B kusy
	82.040.020	20	A	16 bar		20	160
	82.040.025	25	A	16 bar		12	96
	82.040.032	32	A	16 bar		-	42
	82.040.040	40	A	16 bar		-	16
	82.040.050	50	A	16 bar		-	10
	82.040.063	63	A	16 bar		-	12
	82.040.090	90	A	16 bar		-	4
	82.040.110	110	B	16 bar		-	2
	82.040.160	160	B	16 bar		-	1
							

T-kus s vnitřním závitem	Objednáací číslo	Ø	Typ	PN		Balení A kusy	Balení B kusy
	82.041.020.048	20x1/2"	A	16 bar		28	224
	82.041.025.068	25x3/4"	A	16 bar		20	160
	82.041.032.088	32x1"	A	16 bar		-	42
	82.041.040.108	40x1.1/4"	A	16 bar		-	24
	82.041.050.128	50x1.1/2"	A	16 bar		-	15
	82.041.063.168	63x2"	A	16 bar		-	12

Koleno 90°	Objednáací číslo	Ø	Typ	PN		Balení A kusy	Balení B kusy
	82.050.020	20	A	16 bar		32	256
	82.050.025	25	A	16 bar		24	192
	82.050.032	32	A	16 bar		-	64
	82.050.040	40	A	16 bar		-	32
	82.050.050	50	A	16 bar		-	16
	82.050.063	63	A	16 bar		-	12
	82.050.090	90	A	16 bar		-	4
	82.050.110	110	B	16 bar		-	3
	82.050.160	160	B	16 bar		-	1

Koleno 90° s vnějším závitem	Objednáací číslo	Ø	Typ	PN		Balení A kusy	Balení B kusy
	82.052.020.048	20x1/2"	A	16 bar		65	520
	82.052.025.068	25x3/4"	A	16 bar		38	304
	82.052.032.088	32x1"	A	16 bar		18	144
	82.052.040.108	40x1.1/4"	A	16 bar		-	48
	82.052.050.128	50x1.1/2"	A	16 bar		-	32
	82.052.063.168	63x2"	A	16 bar		-	18

Koleno 45°	Objednáací číslo	Ø	Typ	PN		Balení A kusy	Balení B kusy
	82.053.020	20	A	16 bar		40	320
	82.053.025	25	A	16 bar		23	184
	82.053.032	32	A	16 bar		-	60
	82.053.040	40	A	16 bar		-	40
	82.053.050	50	A	16 bar		-	24
	82.053.063	63	A	16 bar		-	12



Přírubový přechod	Objednáací číslo	Ø	Typ	PN		Balení A kusy	Balení B kusy
	82.035.090.248	90x3"	A	16 bar		-	
	82.035.110.328	110x4"	B	16 bar		-	6
	82.035.160.488	160x6"	A	16 bar		-	2

PN16



Redukce	Objednáací číslo	Ø	Typ	PN		Balení A kusy	Balení B kusy
	82.025.025.020	25x20	A	16 bar		65	520
	82.025.032.020	32x20	A	16 bar		-	-
	82.025.032.025	32x25	A	16 bar		60	288
	82.025.040.020	40x20	A	16 bar		24	192
	82.025.040.025	40x25	A	16 bar		24	192
	82.025.040.032	40x32	A	16 bar		24	192
	82.025.050.020	50x20	A	16 bar		-	-
	82.025.050.025	50x25	A	16 bar		-	-
	82.025.050.032	50x32	A	16 bar		-	-
	82.025.050.040	50x40	A	16 bar		-	128
	82.025.063.020	63x20	A	16 bar		-	-
	82.025.063.025	63x25	A	16 bar		-	-
	82.025.063.032	63x32	A	16 bar		-	-
	82.025.063.040	63x40	A	16 bar		-	64
	82.025.063.050	63x50	A	16 bar		-	64
	82.025.090.063	90x63	A	16 bar		-	20
82.025.110.090	110x90	B	16 bar		-	12	

Hliníková trubka	Objednáací číslo	Ø	Délka	PN		Počet trubek v balení	Počet metrů v balení
	86.900.020.106	20	6 M.	16 bar		17	102
	86.900.025.106	25	6 M.	16 bar		23	138
	86.900.032.106	32	6 M.	16 bar		14	84
	86.900.040.106	40	6 M.	16 bar		8	48
	86.900.050.106	50	6 M.	16 bar		5	30
	86.900.063.106	63	6 M.	16 bar		4	24
	86.900.090.106	90	6 M.	16 bar		28	144
	86.900.110.106	110	6 M.	16 bar		15	90
	86.900.160.106	160	6 M.	16 bar		6	36

Spojka	Objednáací číslo	Ø	Typ	PN		Balení A kusy	Balení B kusy
 A  B	86.010.020	20	A	16 bar		50	400
	86.010.025	25	A	16 bar		24	192
	86.010.032	32	A	16 bar		17	136
	86.010.040	40	A	16 bar		-	48
	86.010.050	50	A	16 bar		-	30
	86.010.063	63	A	16 bar		-	24
	86.010.090	90	A	16 bar		-	8
	86.010.110	110	B	16 bar		-	8
	86.010.160	160	B	16 bar		-	21

Posuvná spojka	Objednáací číslo	Ø	Typ	PN		Balení A kusy	Balení B kusy
	86.012.020	20	A	16 bar		50	400
	86.012.025	25	A	16 bar		24	192
	86.012.032	32	A	16 bar		17	136
	86.012.040	40	A	16 bar		-	48
	86.012.050	50	A	16 bar		-	30
	86.012.063	63	A	16 bar		-	24
	86.012.090	90	A	16 bar		-	8

Spojka s vnitřním závitem	Objednáací číslo	Ø	Typ	PN		Balení A kusy	Balení B kusy
	86.030.020.048	20x1/2"	A	16 bar		75	600
	86.030.025.068	25x3/4"	A	16 bar		60	480
	86.030.032.088	32x1"	A	16 bar		32	256
	86.030.040.108	40x1.1/4"	A	16 bar		-	48
	86.030.050.128	50x1.1/2"	A	16 bar		-	40
	86.030.063.168	63x2"	A	16 bar		-	24

Spojka s vnějším závitem	Objednáací číslo	Ø	Typ	PN		Balení A kusy	Balení B kusy
	86.020.020.048	20x1/2"	A	16 bar		75	600
	86.020.020.068	20x3/4"	A	16 bar		75	600
	86.020.025.068	25x3/4"	A	16 bar		60	480
	86.020.025.088	25x1"	A	16 bar		42	336
	86.020.032.088	32x1"	A	16 bar		32	256
	86.020.032.108	32x1.1/4"	A	16 bar		24	192
	86.020.040.108	40x1.1/4"	A	16 bar		-	48
	86.020.040.128	40x1.1/2"	A	16 bar		-	48
	86.020.050.128	50x1.1/2"	A	16 bar		-	40
	86.020.050.168	50x2"	A	16 bar		-	40
	86.020.063.168	63x2"	A	16 bar		-	24
	86.020.063.208	63x2.1/2"	A	16 bar		-	24
	86.020.090.248	90x3"	A	16 bar		-	12

T-kus	Objednáací číslo	Ø	Typ	PN		Balení A kusy	Balení B kusy	
	86.040.020	20	A	16 bar		20	160	
	86.040.025	25	A	16 bar		12	96	
	86.040.032	32	A	16 bar		-	42	
	86.040.040	40	A	16 bar		-	16	
	86.040.050	50	A	16 bar		-	10	
	86.040.063	63	A	16 bar		-	12	
		86.040.090	90	A	16 bar		-	4
		86.040.110	110	B	16 bar		-	2
		86.040.160	160	B	16 bar		-	1

T-kus s vnitřním závitem	Objednáací číslo	Ø	Typ	PN		Balení A kusy	Balení B kusy
	86.041.020.048	20x1/2"	A	16 bar		28	224
	86.041.025.068	25x3/4"	A	16 bar		20	160
	86.041.032.088	32x1"	A	16 bar		-	42
	86.041.040.108	40x1.1/4"	A	16 bar		-	24
	86.041.050.128	50x1.1/2"	A	16 bar		-	15
	86.041.063.168	63x2"	A	16 bar		-	12

Koleno 90°	Objednáací číslo	Ø	Typ	PN		Balení A kusy	Balení B kusy	
	86.050.020	20	A	16 bar		32	256	
	86.050.025	25	A	16 bar		24	192	
	86.050.032	32	A	16 bar		-	64	
	86.050.040	40	A	16 bar		-	32	
	86.050.050	50	A	16 bar		-	16	
	86.050.063	63	A	16 bar		-	12	
		86.050.090	90	A	16 bar		-	4
		86.050.110	110	B	16 bar		-	3
		86.050.160	160	B	16 bar		-	1

Koleno 90° s vnějším závitem	Objednáací číslo	Ø	Typ	PN		Balení A kusy	Balení B kusy
	86.052.020.048	20x1/2"	A	16 bar		65	520
	86.052.025.068	25x3/4"	A	16 bar		38	304
	86.052.032.088	32x1"	A	16 bar		18	144
	86.052.040.108	40x1.1/4"	A	16 bar		-	48
	86.052.050.128	50x1.1/2"	A	16 bar		-	32
	86.052.063.168	63x2"	A	16 bar		-	18

Koleno 45°	Objednáací číslo	Ø	Typ	PN		Balení A kusy	Balení B kusy
	86.053.020	20	A	16 bar		40	320
	86.053.025	25	A	16 bar		23	184
	86.053.032	32	A	16 bar		-	60
	86.053.040	40	A	16 bar		-	40
	86.053.050	50	A	16 bar		-	24
	86.053.063	63	A	16 bar		-	12

Přírubový přechod	Objednáací číslo	Ø	Typ	PN		Balení A kusy	Balení B kusy
	86.035.090.248	90x3"	A	16 bar		-	
	86.035.110.328	110x4"	B	16 bar		-	6
	86.035.160.488	160x6"	A	16 bar		-	2



A

Redukce	Objednáací číslo	Ø	Typ	PN		Balení A kusy	Balení B kusy
	86.025.025.020	25x20	A	16 bar		65	520
	86.025.032.020	32x20	A	16 bar			-
	86.025.032.025	32x25	A	16 bar		60	288
	86.025.040.020	40x20	A	16 bar		24	192
	86.025.040.025	40x25	A	16 bar		24	192
	86.025.040.032	40x32	A	16 bar		24	192
	86.025.050.020	50x20	A	16 bar		-	-
	86.025.050.025	50x25	A	16 bar		-	-
	86.025.050.032	50x32	A	16 bar		-	-
	86.025.050.040	50x40	A	16 bar		-	128
	86.025.063.020	63x20	A	16 bar		-	-
	86.025.063.025	63x25	A	16 bar		-	-
	86.025.063.032	63x32	A	16 bar		-	-
	86.025.063.040	63x40	A	16 bar		-	64
	86.025.063.050	63x50	A	16 bar		-	64
	86.025.090.063	90x63	A	16 bar		-	20
	86.025.110.090	110x90	B	16 bar		-	12
	86.025.160.1100	160x110	B	16 bar		-	4

A



Hliníková trubka	Objednáací číslo	Ø	Délka	PN		Počet trubek v balení	Počet metrů v balení
	87.900.020.106	20	6 M.	16 bar		17	102
	87.900.025.106	25	6 M.	16 bar		23	138
	87.900.032.106	32	6 M.	16 bar		14	84
	87.900.040.106	40	6 M.	16 bar		8	48
	87.900.050.106	50	6 M.	16 bar		5	30
	87.900.063.106	63	6 M.	16 bar		4	24
	87.900.090.106	90	6 M.	16 bar		28	144
	87.900.110.106	110	6 M.	16 bar		15	90
	87.900.160.106	160	6 M.	16 bar		6	36

Spojka	Objednáací číslo	Ø	Typ	PN		Balení A kusy	Balení B kusy
 A  B	87.010.020	20	A	16 bar		50	400
	87.010.025	25	A	16 bar		24	192
	87.010.032	32	A	16 bar		17	136
	87.010.040	40	A	16 bar		-	48
	87.010.050	50	A	16 bar		-	30
	87.010.063	63	A	16 bar		-	24
	87.010.090	90	A	16 bar		-	8
	87.010.110	110	B	16 bar		-	8
	87.010.160	160	B	16 bar		-	2

Posuvná spojka	Objednáací číslo	Ø	Typ	PN		Balení A kusy	Balení B kusy
	87.012.020	20	A	16 bar		50	400
	87.012.025	25	A	16 bar		24	192
	87.012.032	32	A	16 bar		17	136
	87.012.040	40	A	16 bar		-	48
	87.012.050	50	A	16 bar		-	30
	87.012.063	63	A	16 bar		-	24
	87.012.090	90	A	16 bar		-	8

Spojka s vnitřním závitem	Objednáací číslo	Ø	Typ	PN		Balení A kusy	Balení B kusy
	87.030.020.048	20x1/2"	A	16 bar		75	600
	87.030.025.068	25x3/4"	A	16 bar		60	480
	87.030.032.088	32x1"	A	16 bar		32	256
	87.030.040.108	40x1.1/4"	A	16 bar		-	48
	87.030.050.128	50x1.1/2"	A	16 bar		-	40
	87.030.063.168	63x2"	A	16 bar		-	24

Spojka s vnějším závitem	Objednáací číslo	Ø	Typ	PN		Balení A kusy	Balení B kusy
	87.020.020.048	20x1/2"	A	16 bar		75	600
	87.020.020.068	20x3/4"	A	16 bar		75	600
	87.020.025.068	25x3/4"	A	16 bar		60	480
	87.020.025.088	25x1"	A	16 bar		42	336
	87.020.032.088	32x1"	A	16 bar		32	256
	87.020.032.108	32x1.1/4"	A	16 bar		24	192
	87.020.040.108	40x1.1/4"	A	16 bar		-	48
	87.020.040.128	40x1.1/2"	A	16 bar		-	48
	87.020.050.128	50x1.1/2"	A	16 bar		-	40
	87.020.050.168	50x2"	A	16 bar		-	40
	87.020.063.168	63x2"	A	16 bar		-	24
	87.020.063.208	63x2.1/2"	A	16 bar		-	24
	87.020.090.248	90x3"	A	16 bar		-	12

T-kus	Objednáací číslo	Ø	Typ	PN		Balení A kusy	Balení B kusy	
	87.040.020	20	A	16 bar		20	160	
	87.040.025	25	A	16 bar		12	96	
	87.040.032	32	A	16 bar		-	42	
	87.040.040	40	A	16 bar		-	16	
	87.040.050	50	A	16 bar		-	10	
	87.040.063	63	A	16 bar		-	12	
		87.040.090	90	A	16 bar		-	4
		87.040.110	110	B	16 bar		-	2
		87.040.160	160	B	16 bar		-	1

PN16

T-kus s vnitřním závitem	Objednáací číslo	Ø	Typ	PN		Balení A kusy	Balení B kusy
	87.041.020.048	20x1/2"	A	16 bar		28	224
	87.041.025.068	25x3/4"	A	16 bar		20	160
	87.041.032.088	32x1"	A	16 bar		-	42
	87.041.040.108	40x1.1/4"	A	16 bar		-	24
	87.041.050.128	50x1.1/2"	A	16 bar		-	15
	87.041.063.168	63x2"	A	16 bar		-	12

Koleno 90°	Objednáací číslo	Ø	Typ	PN		Balení A kusy	Balení B kusy	
	87.050.020	20	A	16 bar		32	256	
	87.050.025	25	A	16 bar		24	192	
	87.050.032	32	A	16 bar		-	64	
	87.050.040	40	A	16 bar		-	32	
	87.050.050	50	A	16 bar		-	16	
		87.050.063	63	A	16 bar		-	12
		87.050.090	90	A	16 bar		-	4
		87.050.110	110	B	16 bar		-	2
		87.050.160	160	B	16 bar		-	1

Koleno 90° s vnějším závitem



Objednáací číslo	∅	Typ	PN		Balení A kusy	Balení B kusy
87.052.020.048	20x1/2"	A	16 bar		65	520
87.052.025.068	25x3/4"	A	16 bar		38	304
87.052.032.088	32x1"	A	16 bar		18	144
87.052.040.108	40x1.1/4"	A	16 bar		-	48
87.052.050.128	50x1.1/2"	A	16 bar		-	32
87.052.063.168	63x2"	A	16 bar		-	18

Koleno 45°



Objednáací číslo	∅	Typ	PN		Balení A kusy	Balení B kusy
87.053.020	20	A	16 bar		40	320
87.053.025	25	A	16 bar		23	184
87.053.032	32	A	16 bar		-	60
87.053.040	40	A	16 bar		-	40
87.053.050	50	A	16 bar		-	24
87.053.063	63	A	16 bar		-	12

Přírubový přechod



A



B

Objednáací číslo	∅	Typ	PN		Balení A kusy	Balení B kusy
87.035.090.248	90x3"	A	16 bar		-	
87.035.110.328	110x4"	B	16 bar		-	6
87.035.160.488	160x6"	A	16 bar		-	2

Redukce



A

Objednáací číslo	∅	Typ	PN		Balení A kusy	Balení B kusy
87.025.025.020	25x20	A	16 bar		65	520
87.025.032.020	32x20	A	16 bar			-
87.025.032.025	32x25	A	16 bar		60	288
87.025.040.020	40x20	A	16 bar		24	192
87.025.040.025	40x25	A	16 bar		24	192
87.025.040.032	40x32	A	16 bar		24	192
87.025.050.020	50x20	A	16 bar		-	-
87.025.050.025	50x25	A	16 bar		-	-
87.025.050.032	50x32	A	16 bar		-	-
87.025.050.040	50x40	A	16 bar		-	128
87.025.063.020	63x20	A	16 bar		-	-
87.025.063.025	63x25	A	16 bar		-	-
87.025.063.032	63x32	A	16 bar		-	-
87.025.063.040	63x40	A	16 bar		-	64
87.025.063.050	63x50	A	16 bar		-	64
87.025.090.063	90x63	A	16 bar		-	20
87.025.110.090	110x90	B	16 bar		-	12
87.025.160.110	160x110	B	16 bar		-	4

Hliníková trubka	Objednáací číslo	Ø	Délka	PN		Počet trubek v balení	Počet metrů v balení
	84.900.020.104	20	4 M.	<-10mBar		17	68
	84.900.025.104	25	4 M.	<-10mBar		23	92
	84.900.032.104	32	4 M.	<-10mBar		14	56
	84.900.020.106	20	6 M.	<-10mBar		17	102
	84.900.025.106	25	6 M.	<-10mBar		23	138
	84.900.032.106	32	6 M.	<-10mBar		14	84
	84.900.040.106	40	6 M.	<-10mBar		8	48
	84.900.050.106	50	6 M.	<-10mBar		5	30
	84.900.063.106	63	6 M.	<-10mBar		4	24
	84.900.090.106	90	6 M.	<-10mBar		28	144
	84.900.110.106	110	6 M.	<-10mBar		15	90
	84.900.160.106	160	6 M.	<-10mBar		6	36



Spojka	Objednáací číslo	Ø	Typ	PN		Balení A kusy	Balení B kusy
 A	84.010.020	20	A	<-10mBar		50	400
	84.010.025	25	A	<-10mBar		24	192
	84.010.032	32	A	<-10mBar		17	136
	84.010.040	40	A	<-10mBar		-	48
	84.010.050	50	A	<-10mBar		-	30
	84.010.063	63	A	<-10mBar		-	24
	84.010.090	90	A	<-10mBar		-	8
	84.010.110	110	B	<-10mBar		-	6
 B	84.010.160	160	B	<-10mBar		-	2

PN-0,87

Posuvná spojka	Objednáací číslo	Ø	Typ	PN		Balení A kusy	Balení B kusy
	84.012.020	20	A	<-10mBar		50	400
	84.012.025	25	A	<-10mBar		24	192
	84.012.032	32	A	<-10mBar		17	136
	84.012.040	40	A	<-10mBar		-	48
	84.012.050	50	A	<-10mBar		-	30
	84.012.063	63	A	<-10mBar		-	24
	84.012.090	90	A	<-10mBar		-	8

Spojka s vnitřním závitem	Objednáací číslo	Ø	Typ	PN		Balení A kusy	Balení B kusy
	84.030.020.048	20x1/2"	A	<-10mBar		75	600
	84.030.025.068	25x3/4"	A	<-10mBar		60	480
	84.030.032.088	32x1"	A	<-10mBar		32	256
	84.030.040.108	40x1.1/4"	A	<-10mBar		-	48
	84.030.050.128	50x1.1/2"	A	<-10mBar		-	40
	84.030.063.168	63x2"	A	<-10mBar		-	24

Spojka s vnějším závitem	Objednáací číslo	Ø	Typ	PN		Balení A kusy	Balení B kusy
	84.020.020.048	20x1/2"	A	<-10mBar		75	600
	84.020.020.068	20x3/4"	A	<-10mBar		75	600
	84.020.025.068	25x3/4"	A	<-10mBar		60	480
	84.020.025.088	25x1"	A	<-10mBar		42	336
	84.020.032.088	32x1"	A	<-10mBar		32	256
	84.020.032.108	32x1.1/4"	A	<-10mBar		24	192
	84.020.040.108	40x1.1/4"	A	<-10mBar		-	48
	84.020.040.128	40x1.1/2"	A	<-10mBar		-	48
	84.020.050.128	50x1.1/2"	A	<-10mBar		-	40
	84.020.050.168	50x2"	A	<-10mBar		-	40
	84.020.063.168	63x2"	A	<-10mBar		-	24
	84.020.063.208	63x2.1/2"	A	<-10mBar		-	24
	84.020.090.248	90x3"	A	<-10mBar		-	12

T-kus	Objednáací číslo	Ø	Typ	PN		Balení A kusy	Balení B kusy
	84.040.020	20	A	<-10mBar		20	160
	84.040.025	25	A	<-10mBar		12	96
	84.040.032	32	A	<-10mBar		-	42
	84.040.040	40	A	<-10mBar		-	16
	84.040.050	50	A	<-10mBar		-	10
	84.040.063	63	A	<-10mBar		-	12
	84.040.090	90	A	<-10mBar		-	4
	84.040.110	110	B	<-10mBar		-	2
	84.040.160	160	B	<-10mBar		-	1
							

T-kus vnitřním závitem	Objednáací číslo	Ø	Typ	PN		Balení A kusy	Balení B kusy
	84.041.020.048	20x1/2"	A	<-10mBar		28	224
	84.041.025.068	25x3/4"	A	<-10mBar		20	160
	84.041.032.088	32x1"	A	<-10mBar		-	42
	84.041.040.108	40x1.1/4"	A	<-10mBar		-	24
	84.041.050.128	50x1.1/2"	A	<-10mBar		-	15
	84.041.063.168	63x2"	A	<-10mBar		-	12

Koleno 90°	Objednáací číslo	Ø	Typ	PN		Balení A kusy	Balení B kusy
	84.050.020	20	A	<-10mBar		32	256
	84.050.025	25	A	<-10mBar		24	192
	84.050.032	32	A	<-10mBar		-	64
	84.050.040	40	A	<-10mBar		-	32
	84.050.050	50	A	<-10mBar		-	16
	84.050.063	63	A	<-10mBar		-	12
	84.050.090	90	A	<-10mBar		-	4
	84.050.110	110	B	<-10mBar		-	3
	84.050.160	160	B	<-10mBar		-	1
							

Koleno 90° s vnějším závitem	Objednáací číslo	Ø	Typ	PN		Balení A kusy	Balení B kusy
	84.052.020.048	20x1/2"	A	<-10mBar		65	520
	84.052.025.068	25x3/4"	A	<-10mBar		38	304
	84.052.032.088	32x1"	A	<-10mBar		18	144
	84.052.040.108	40x1.1/4"	A	<-10mBar		-	48
	84.052.050.128	50x1.1/2"	A	<-10mBar		-	32
	84.052.063.168	63x2"	A	<-10mBar		-	18
Koleno 45°	Objednáací číslo	Ø	Typ	PN		Balení A kusy	Balení B kusy
	84.053.020	20	A	<-10mBar		40	320
	84.053.025	25	A	<-10mBar		23	184
	84.053.032	32	A	<-10mBar		-	60
	84.053.040	40	A	<-10mBar		-	40
	84.053.050	50	A	<-10mBar		-	24
	84.053.063	63	A	<-10mBar		-	12
Přírubový přechod	Objednáací číslo	Ø	Typ	PN		Balení A kusy	Balení B kusy
 A	84.035.090.248	90x3"	A	<-10mBar		-	
	84.035.110.328	110x4"	B	<-10mBar		-	6
	84.035.160.488	160x6"	A	<-10mBar		-	2
 B							
Redukce	Objednáací číslo	Ø	Typ	PN		Balení A kusy	Balení B kusy
 A	84.025.025.020	25x20	A	<-10mBar		65	520
	84.021.032.020	32x20	A	<-10mBar			-
	84.025.032.025	32x25	A	<-10mBar		60	288
	84.025.040.020	40x20	A	<-10mBar		24	192
	84.025.040.025	40x25	A	<-10mBar		24	192
	84.025.040.032	40x32	A	<-10mBar		24	192
	84.025.050.020	50x20	A	<-10mBar		-	-
	84.025.050.025	50x25	A	<-10mBar		-	-
	84.025.050.032	50x32	A	<-10mBar		-	-
	84.025.050.040	50x40	A	<-10mBar		-	128
	84.025.063.020	63x20	A	<-10mBar		-	-
	84.025.063.025	63x25	A	<-10mBar		-	-
	84.025.063.032	63x32	A	<-10mBar		-	-
	84.025.063.040	63x40	A	<-10mBar		-	64
	84.025.063.050	63x50	A	<-10mBar		-	64
	84.025.090.063	90x63	A	<-10mBar		-	20
	84.025.110.090	110x90	B	<-10mBar		-	12
	84.025.160.110	160x110	B	<-10mBar		-	4

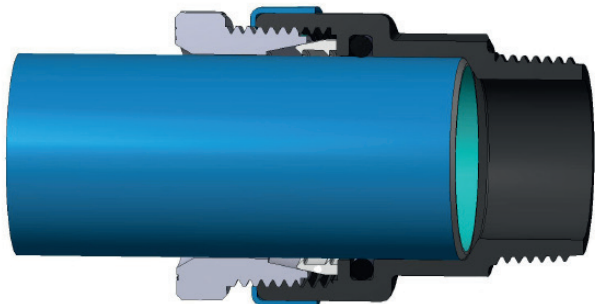

Spojky D20- D90

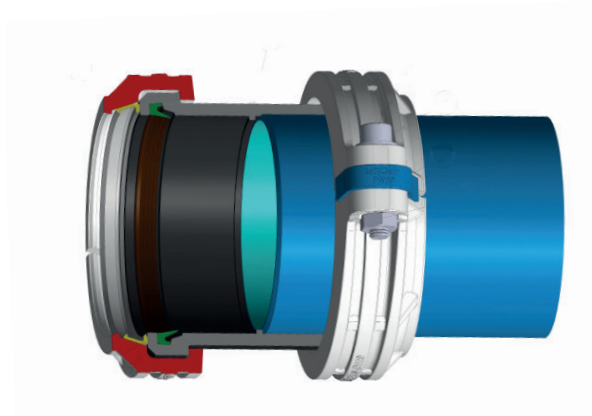

Spojky D110- D160

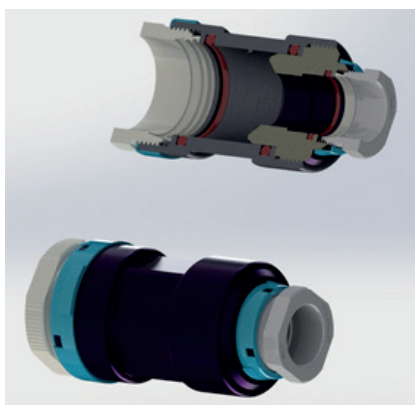

Ukázka redukce



Ukázka příruby D110- D160

EQO *air*HP EQO *oil*HP - EQO *h20*HP

Fitinky a trubky pro dopravu stlačeného vzduchu od průměru D20 do D160 mm- Pracovní tlak 70 bar

Fittings and Pipes able to Transport Pressurised Air from D20 up to D160- Working Pressure 70Bars

Fitinky a trubky pro dopravu oleje od průměru D20 do D32 mm- Pracovní tlak 70 bar

Fittings and Pipes able to Transport Engine Pressurised Oil from D20 up to D32- Working Pressure 70Bars

Fitinky a trubky pro dopravu vody od průměru D20 do D25 mm- Pracovní tlak 70 bar

Fittings and Pipes able to transport Water from D20 up to D25- Working Pressure 200Bars



Hliníková trubka	Objednáací číslo	Ø	Délka	PN		Počet trubek v balení	Počet metrů v balení
	85.900.020.104	20	4 m.	70 bar		17	68
	85.900.025.104	25	4 m.	70 bar		23	92
	85.900.032.104	32	4 m.	70 bar		14	56
	85.900.040.104	40	4 m.	70 bar		8	32
	85.900.050.104	50	4 m.	70 bar		5	20
	85.900.063.104	63	4 m.	70 bar		4	16

Spojka	Objednáací číslo	Ø	Typ	PN		Balení A kusy	Balení B kusy
	85.010.020	20	A	70 bar		50	400
	85.010.025	25	A	70 bar		24	192
	85.010.032	32	A	70 bar		17	136
	85.010.040	40	A	70 bar		-	48
	85.010.050	50	A	70 bar		-	30
	85.010.063	63	A	70 bar		-	24

Posuvná spojka	Objednáací číslo	Ø	Typ	PN		Balení A kusy	Balení B kusy
	85.012.020	20	A	70 bar		50	400
	85.012.025	25	A	70 bar		24	192
	85.012.032	32	A	70 bar		17	136
	85.012.040	40	A	70 bar		-	48
	85.012.050	50	A	70 bar		-	30
	85.012.063	63	A	70 bar		-	24

Spojka s vnitřním závitem	Objednáací číslo	Ø	Typ	PN		Balení A kusy	Balení B kusy
	85.030.020.048	20x1/2"	A	70 bar		75	600
	85.030.025.068	25x3/4"	A	70 bar		60	480
	85.030.032.088	32x1"	A	70 bar		32	256
	85.030.040.108	40x1.1/4"	A	70 bar		-	48
	85.030.050.128	50x1.1/2"	A	70 bar		-	40
	85.030.063.168	63x2"	A	70 bar		-	24

Spojka s vnějším závitem	Objednáací číslo	ø	Typ	PN		Balení A kusy	Balení B kusy
	85.020.020.048	20x1/2"	A	70 bar		75	600
	85.020.020.068	20x3/4"	A	70 bar		75	600
	85.020.025.068	25x3/4"	A	70 bar		60	480
	85.020.025.088	25x1"	A	70 bar		42	336
	85.020.032.088	32x1"	A	70 bar		32	256
	85.020.032.108	32x1.1/4"	A	70 bar		24	192
	85.020.040.108	40x1.1/4"	A	70 bar		-	48
	85.020.040.128	40x1.1/2"	A	70 bar		-	48
	85.020.050.128	50x1.1/2"	A	70 bar		-	40
	85.020.050.168	50x2"	A	70 bar		-	40
	85.020.063.168	63x2"	A	70 bar		-	24
	85.020.063.208	63x2.1/2"	A	70 bar		-	24

T-kus	Objednáací číslo	ø	Typ	PN		Balení A kusy	Balení B kusy
	85.040.020	20	A	70 bar		20	160
	85.040.025	25	A	70 bar		12	96
	85.040.032	32	A	70 bar		-	42
	85.040.040	40	A	70 bar		-	16
	85.040.050	50	A	70 bar		-	10
	85.040.063	63	A	70 bar		-	12

T-kus vnitřním závitem	Objednáací číslo	ø	Typ	PN		Balení A kusy	Balení B kusy
	85.041.020.048	20x1/2"	A	70 bar		28	224
	85.041.025.068	25x3/4"	A	70 bar		20	160
	85.041.032.088	32x1"	A	70 bar		-	42
	85.041.040.108	40x1.1/4"	A	70 bar		-	24
	85.041.050.128	50x1.1/2"	A	70 bar		-	15
	85.041.063.168	63x2"	A	70 bar		-	12

Koleno 90°	Objednáací číslo	ø	Typ	PN		Balení A kusy	Balení B kusy
	85.050.020	20	A	70 bar		32	256
	85.050.025	25	A	70 bar		24	192
	85.050.032	32	A	70 bar		-	64
	85.050.040	40	A	70 bar		-	32
	85.050.050	50	A	70 bar		-	16
	85.050.063	63	A	70 bar		-	12

Koleno 90° s vnějším závitem



Objednáací číslo	∅	Typ	PN		Balení A kusy	Balení B kusy
85.052.020.048	20x1/2"	A	70 bar		65	520
85.052.025.068	25x3/4"	A	70 bar		38	304
85.052.032.088	32x1"	A	70 bar		18	144
85.052.040.108	40x1.1/4"	A	70 bar		-	48
85.052.050.128	50x1.1/2"	A	70 bar		-	32
85.052.063.168	63x2"	A	70 bar		-	18

Koleno 45°



Objednáací číslo	∅	Typ	PN		Balení A kusy	Balení B kusy
85.053.020	20	A	70 bar		40	320
85.053.025	25	A	70 bar		23	184
85.053.032	32	A	70 bar		-	60
85.053.040	40	A	70 bar		-	40
85.053.050	50	A	70 bar		-	24
85.053.063	63	A	70 bar		-	12

Redukce





Objednáací číslo	∅	Typ	PN		Balení A kusy	Balení B kusy
85.025.025.020	25x20		70 bar		65	520
85.025.032.020	32x20		70 bar		-	-
85.025.032.025	32x25		70 bar		60	288
85.025.040.020	40x20		70 bar		24	192
85.025.040.025	40x25		70 bar		24	192
85.025.040.032	40x32		70 bar		24	192
85.025.050.020	50x20		70 bar		-	-
85.025.050.025	50x25		70 bar		-	-
85.025.050.032	50x32		70 bar		-	-
85.025.050.040	50x40		70 bar		-	128
85.025.063.020	63x20		70 bar		-	-
85.025.063.025	63x25		70 bar		-	-
85.025.063.032	63x32		70 bar		-	-
85.025.063.040	63x40		70 bar		-	64
85.025.063.050	63x50		70 bar		-	64

PN 70

Hliníková trubka	Objednáací číslo	Ø	Délka	PN		Počet trubek v balení	Počet metrů v balení
	80.900.020.104	20	4 M.	70 bar		17	68
	80.900.025.104	25	4 M.	70 bar		23	92
	80.900.032.104	32	4 M.	70 bar		14	56

Spojka	Objednáací číslo	Ø	Typ	PN		Balení A kusy	Balení B kusy
	80.010.020	20	A	70 bar		50	400
	80.010.025	25	A	70 bar		24	192
	80.010.032	32	A	70 bar		17	136

Posuvná spojka	Objednáací číslo	Ø	Typ	PN		Balení A kusy	Balení B kusy
	80.012.020	20	A	70 bar		50	400
	80.012.025	25	A	70 bar		24	192
	80.012.032	32	A	70 bar		17	136

Spojka s vnitřním závitem	Objednáací číslo	Ø	Typ	PN		Balení A kusy	Balení B kusy
	80.030.020.048	20x1/2"	A	70 bar		75	600
	80.030.025.068	25x3/4"	A	70 bar		60	480
	80.030.032.088	32x1"	A	70 bar		32	256

Spojka s vnějším závitem	Objednáací číslo	Ø	Typ	PN		Balení A kusy	Balení B kusy
	80.020.020.048	20x1/2"	A	70 bar		75	600
	80.020.020.068	20x3/4"	A	70 bar		75	600
	80.020.025.068	25x3/4"	A	70 bar		60	480
	80.020.025.088	25x1"	A	70 bar		42	336
	80.020.032.088	32x1"	A	70 bar		32	256
	80.020.032.108	32x1.1/4"	A	70 bar		24	192

T-kus	Objednáací číslo	Ø	Typ	PN		Balení A kusy	Balení B kusy
	80.040.020	20	A	70 bar		20	160
	80.040.025	25	A	70 bar		12	96
	80.040.032	32	A	70 bar		-	42

T-kus vnitřním závitem	Objednáací číslo	Ø	Typ	PN		Balení A kusy	Balení B kusy
	80.041.020.048	20x1/2"	A	70 bar		28	224
	80.041.025.068	25x3/4"	A	70 bar		20	160
	80.041.032.088	32x1"	A	70 bar		-	42

Koleno 90°	Objednáací číslo	Ø	Typ	PN		Balení A kusy	Balení B kusy
	80.050.020	20	A	70 bar		32	256
	80.050.025	25	A	70 bar		24	192
	80.050.032	32	A	70 bar		-	64

Koleno 90° s vnějším závitem	Objednáací číslo	Ø	Typ	PN		Balení A kusy	Balení B kusy
	80.052.020.048	20x1/2"	A	70 bar		65	520
	80.052.025.068	25x3/4"	A	70 bar		38	304
	80.052.032.088	32x1"	A	70 bar		18	144

Koleno 45°	Objednáací číslo	Ø	Typ	PN		Balení A kusy	Balení B kusy
	80.053.020	20	A	70 bar		40	320
	80.053.025	25	A	70 bar		23	184
	80.053.032	32	A	70 bar		-	60

Redukce	Objednáací číslo	Ø	Typ	PN		Balení A kusy	Balení B kusy
	80.025.025.020	25x20	A	70 bar		65	520
	80.025.032.020	32x20	A	70 bar		-	-
	80.025.032.025	32x25	A	70 bar		60	288

Hliníková trubka	Objednáací číslo	Ø	Délka	PN		Počet trubek v balení	Počet metrů v balení
	81.900.020.106	20	6 m.	200 bar		17	102
	81.900.025.106	25	6 m.	200 bar		23	138

Spojka	Objednáací číslo	Ø	Typ	PN		Balení A kusy	Balení B kusy
	81.010.020	20	A	200 bar		50	400
	81.010.025	25	A	200 bar		24	192

Posuvná spojka	Objednáací číslo	Ø	Typ	PN		Balení A kusy	Balení B kusy
	81.012.020	20	A	200 bars		50	400
	81.012.025	25	A	200 bars		24	192

Spojka s vnitřním závitem	Objednáací číslo	Ø	Typ	PN		Balení A kusy	Balení B kusy
	81.030.020.048	20x1/2"	A	200 bar		75	600
	81.030.025.068	25x3/4"	A	200 bar		60	480

Spojka s vnějším závitem	Objednáací číslo	Ø	Typ	PN		Balení A kusy	Balení B kusy
	81.020.020.048	20x1/2"	A	200 bar		75	600
	81.020.020.068	20x3/4"	A	200 bar		75	600
	81.020.025.068	25x3/4"	A	200 bar		60	480
	81.020.025.088	25x1"	A	200 bar		42	336

T-kus	Objednáací číslo	Ø	Typ	PN		Balení A kusy	Balení B kusy
	81.040.020	20	A	200 bar		20	160
	81.040.025	25	A	200 bar		12	96

T-kus s vnitřním závitem	Objednáací číslo	Ø	Typ	PN		Balení A kusy	Balení B kusy
	81.041.020.048	20x1/2"	A	200 bar		28	224
	81.041.025.068	25x3/4"	A	200 bar		20	160

Koleno 90°	Objednáací číslo	Ø	Typ	PN		Balení A kusy	Balení B kusy
	81.050.020	20	A	200 bar		32	256
	81.050.025	25	A	200 bar		24	192

Koleno 90° s vnějším závitem	Objednáací číslo	Ø	Typ	PN		Balení A kusy	Balení B kusy
	81.052.020.048	20x1/2"	A	200 bar		65	520
	81.052.025.068	25x3/4"	A	200 bar		38	304

Koleno 45°	Objednáací číslo	Ø	Typ	PN		Balení A kusy	Balení B kusy
	81.053.020	20	A	200 bar		40	320
	81.053.025	25	A	200 bar		23	184

Redukce	Objednáací číslo	Ø	Typ	PN		Balení A kusy	Balení B kusy
	81.025.025.020	25x20	A	200 bar		65	520

EQO*fluids*

■ Příslušenství pro dopravu stlačeného vzduchu, jiných plynů a kapalin od průměru D 20 do D 160 mm, tlak 16Bar- 70Bar- 200Bar

■ Accessories able to transport Pressurised Air and other fluids from D20 up to D160- Working Pressure 16Bar- 70Bar 200Bar

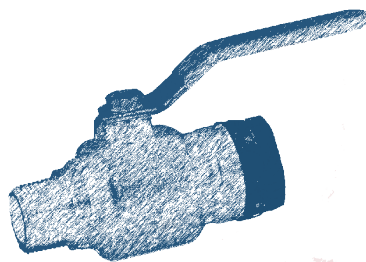
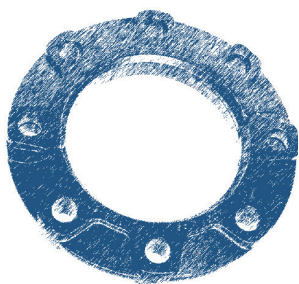

Závitová odbočka	Objednáací číslo	Ø	Typ	PN		Balení A kusy	Balení B kusy
	89.835.025.048	25x1/2"		40 bar		48	384
	89.835.032.048	32x1/2"		40 bar		36	288
	89.835.040.048	40x1/2"		40 bar		20	160
	89.835.040.068	40x3/4"		40 bar		20	160
	89.835.050.048	50x1/2"		40 bar		16	128
	89.835.050.068	50x3/4"		40 bar		16	128
	89.835.050.088	50x1"		40 bar		16	128
	89.835.063.048	63x1/2"		40 bar		-	45
	89.835.063.068	63x3/4"		40 bar		-	45
	89.835.063.088	63x1"		40 bar		-	45
	89.835.090.088	90x1"		40 bar		-	20
	89.835.090.168	90x2"		16 bar		-	20
	89.835.110.088	110x1"		16 bar		-	20
	89.835.110.168	110x2"		16 bar		-	20
	89.835.160.168	160X2"		16 bar		-	4
	89.835.160.248	160X3"		16 bar		-	4

Odbočka na trubku	Objednáací číslo	Ø	Typ	PN		Balení A kusy	Balení B kusy
	89.830.025.020	25x20		40 bar		20	160
	89.830.032.020	32x20		40 bar		20	160
	89.830.040.020	40x20		40 bar			40
	89.830.040.025	40x25		40 bar			40
	89.830.050.020	50x20		40 bar			36
	89.830.050.025	50x25		40 bar			36
	89.830.063.020	63x20		40 bar			36
	89.830.063.025	63x25		40 bar			36

Rozdělovač	Objednáací číslo	Ø	Typ	PN		Balení A kusy	Balení B kusy
	89.844.048	1/2"	A	70 bar		18	144
	89.845.048	1/2"	B	70 bar			48
	89.847.048	1/2"	C	70 bar			32
	89.844.068.048	3/4"x1/2"	A	70 bar		18	144
	89.845.068.048	3/4"x1/2"	B	70 bar			48
	89.847.068.048	3/4"x1/2"	C	70 bar			32

Zahnuté koleno	Objednáací číslo	Ø	Typ	PN		Balení A kusy	Balení B kusy
	89.861.048	1/2"x1/2"		70 bar		96	768

Ukončení, nástěnka	Objednáací číslo	Ø	Typ	PN		Balení A kusy	Balení B kusy
 1P 2P	89.841.025.048	25x1/2"	1P	16 bar			
	89.842.025.048	25x1/2"x1/2"	2P	16 bar			

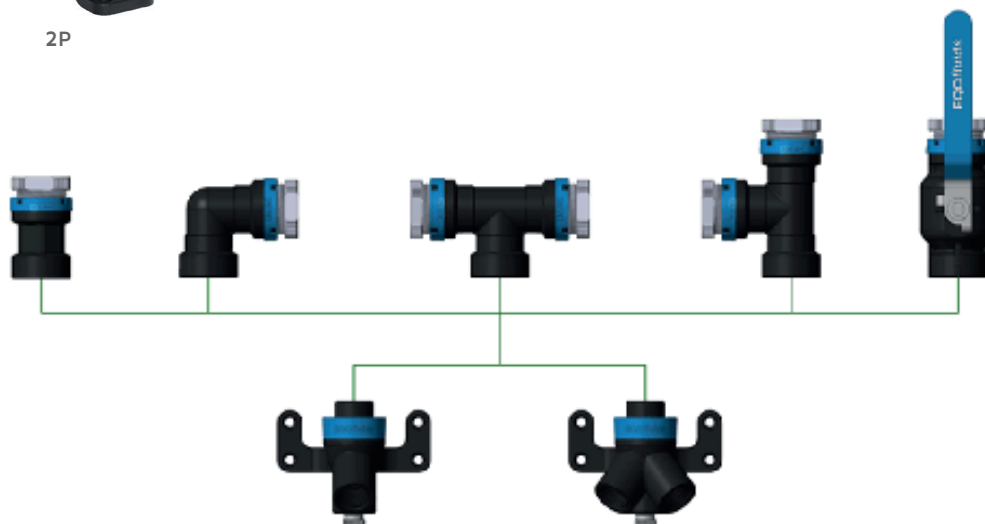



Ukončení s kulovým kohoutem, jeden vývod	Objednáací číslo	Ø	Typ	PN		Balení A kusy	Balení B kusy
	89.885.020.048	20x1/2"		16 bar		2	16
	89.885.025.048	25x1/2"		16 bar		2	16

Ukončení s kulovým kohoutem, dva vývody	Objednáací číslo	Ø	Typ	PN		Balení A kusy	Balení B kusy
	89.886.020.048	20x1/2"		16 bar		2	16
	89.886.025.048	25x1/2"		16 bar		2	16



Kulový kohout	Objednáací číslo	Ø	Typ	PN	Balení A kusy	Balení B kusy
	89.881.020.020	20		16 bar	8	128
	89.881.025.020	25x20		16 bar	8	128
	89.881.025.025	25		16 bar	4	64
	89.881.032.032	32		16 bar		
	89.881.040.040	40		16 bar		
	89.881.050.050	50		16 bar		
	89.881.063.063	63		16 bar		

Kulový kohout se závitem	Objednáací číslo	Ø	Délka	PN	Balení A kusy	Balení B kusy
	89.882.020.048	20x1/2"		16 bar	8	128
	89.882.025.068	25x3/4"		16 bar	4	64
	89.882.032.088	32x1"		16 bar		
	89.882.040.108	40x1.1/4"		16 bar		
	89.882.050.128	50x1.1/2"		16 bar		
	89.882.063.168	63x2		16 bar		

Kulový kohout HP	Objednáací číslo	Ø	Délka	PN	Balení A kusy	Balení B kusy
HP 	89.891.020.020	20		40 bar	8	128
	89.891.025.020	25x20		40 bar	8	128
	89.891.025.025	25		40 bar	4	64
	89.891.032.032	32		40 bar		
	89.891.040.040	40		40 bar		
	89.891.050.050	50		40 bar		
	89.891.063.063	63		40 bar		

Kulový kohout se závitem HP	Objednáací číslo	Ø	Délka	PN	Balení A kusy	Balení B kusy
HP 	89.892.020.048	20x1/2"		40 bar	8	128
	89.892.025.068	25x3/4"		40 bar	4	64
	89.892.032.088	32x1"		40 bar		
	89.892.040.108	40x1.1/4"		40 bar		
	89.892.050.128	50x1.1/2"		40 bar		
	89.892.063.168	63x2		40 bar		

Bezpečnostní madlo	Objednáací číslo	Ø	Délka	PN	Balení A kusy	Balení B kusy
	89.888.020	20		-	10	250
	89.888.025	25		-	10	250
	89.888.032	32		-	10	250
	89.888.040	40		-	10	250
	89.888.050	50		-	10	250
	89.888.063	63		-	10	250

Flexibilní hadice 16 bar	Objednací číslo	Ø	Délka	Typ	PN	Balení B kusy
 A	89.920.020.103	20	300mm	A	16 bar	5
	89.920.020.110	20	1000mm	A	16 bar	5
	89.920.025.103	25	300mm	A	16 bar	4
	89.920.025.110	25	1000mm	A	16 bar	4
	89.920.032.103	32	300mm	A	16 bar	6
	89.920.032.110	32	1000mm	A	16 bar	6
	89.920.040.105	40	500mm	A	16 bar	5
	89.920.040.110	40	1000mm	A	16 bar	5
	89.920.050.105	50	500mm	A	16 bar	4
	89.920.050.110	50	1000mm	A	16 bar	4
 B	89.920.063.105	63	500mm	A	16 bar	4
	89.920.063.110	63	1000mm	A	16 bar	4
	89.920.090.105	90	500mm	B	16 bar	1
	89.920.090.110	90	1000mm	B	16 bar	1
	89.920.110.105	110	500mm	B	16 bar	1
	89.920.110.110	110	1000mm	B	16 bar	1
	89.920.160.105	160	500mm	B	16 bar	1

Speciální rozměry je možno vyrobit na vyžádání

Flexibilní hadice 40 bar	Objednací číslo	Ø	Délka	Typ	PN	Balení B kusy
 A	89.921.020.103	20	300mm	A	40 bar	5
	89.921.020.110	20	1000mm	A	40 bar	5
	89.921.025.103	25	300mm	A	40 bar	4
	89.921.025.110	25	1000mm	A	40 bar	4
	89.921.032.103	32	300mm	A	40 bar	6
	89.921.032.110	32	1000mm	A	40 bar	6
	89.921.040.105	40	500mm	A	40 bar	5
	89.921.040.110	40	1000mm	A	40 bar	5
	89.921.050.105	50	500mm	A	40 bar	4
	89.921.050.110	50	1000mm	A	40 bar	4
 HP	89.921.063.105	63	500mm	B	40 bar	4
	89.921.063.110	63	1000mm	B	40 bar	4

Speciální délky je možno vyrobit na vyžádání

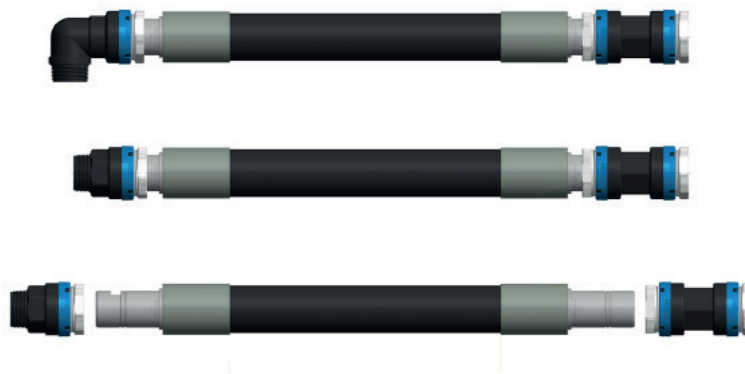



Příruba	Objednáací číslo	Ø	PN		Balení A kusy	Balení B kusy
	89.838.110	DN100 - 4"	16 bar			
	89.838.140	DN140 - 5"	16 bar			
	89.838.160	DN160 - 6"	16 bar			10

Speciální příruba pro T-kus a kolena	Objednáací číslo	Ø	PN		Balení A kusy	Balení B kusy
	89.839.110	DN100 - 4"	16 bar			
	89.839.140	DN140 - 5"	16 bar			
	89.839.160	DN160 - 6"	16 bar			10

Zástrčka	Objednáací číslo	Ø		PN		Balení A kusy	Balení B kusy
	89.866.020	20		70 bar		10	-
	89.866.025	25		70 bar		10	-
	89.866.032	32		70 bar		10	-
	89.866.040	40		70 bar		10	-
	89.866.050	50		70 bar		10	-
	89.866.063	63		70 bar		10	-
	89.866.090	90		70 bar		5	-

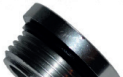
Zástrčka s odkalením pro příruba	Objednáací číslo	Ø		Pn		Balení A kusy	Balení B kusy
	89.837.110	DN100 - 4"		16 bar			10
	89.839.140	DN140 - 5"		16 bar			
	89.837.160	DN160 - 6"		16 bar			10

Závitová zátka	Objednáací číslo	Ø		PN		Balení A kusy	Balení B kusy
	89.862.068	3/4"		70 bar		10	-
	89.862.088	1"		70 bar		10	-

Redukce	Objednáací číslo	Ø		PN		Balení A kusy	Balení B kusy
	89.860.068.048	3/4"x1/2"		70 bar		5	-
	89.860.088.048	1"x1/2"		70 bar		5	-
	89.860.088.068	1x3/4"		70 bar		5	-
	89.860.108.068	1.1/4"x3/4"		70 bar		5	-
	89.860.108.088	1.1/4"x1"		70 bar		5	-
	89.860.128.088	1.1/2"x1"		70 bar		5	-
	89.860.128.108	1.1/2"x1.1/4"		70 bar		5	-
	89.860.168.088	2"x1"		70 bar		5	-
	89.860.168.108	2x1.1/4"		70 bar		5	-
	89.860.168.128	2x1.1/2"		70 bar		5	-
	89.860.248.128	3"x1.1/2"		70 bar		5	-
	89.860.248.168	3"x2"		70 bar		5	-

Matice pro fitinky	Objednáací číslo	Ø				Balení A kusy	Balení B kusy
	89.192.020	20		-		10	-
	89.192.025	25		-		10	-
	89.192.032	32		-		10	-
	89.192.040	40		-		10	-
	89.192.050	50		-		10	-
	89.192.063	63		-		10	-
	89.192.090	90		-		10	-

Nerezový svěrný kroužek	Objednáací číslo	Ø				Balení A kusy	Balení B kusy
	89.190.020	20		-		10	-
	89.190.025	25		-		10	-
	89.190.032	32		-		10	-
	89.190.040	40		-		10	-
	89.190.050	50		-		10	-
	89.190.063	63		-		10	-
	89.190.090	90		-		10	-
	89.190.110	110		-		10	-
	89.190.160	160		-		10	-

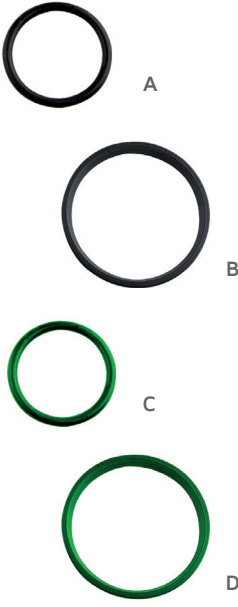
Těsnění pro fitinky	Objednáací číslo	Ø	Délka	PN		Balení A kusy	Balení B kusy
	89.191.020	20	A	NBR		10	-
	89.191.025	25	A	NBR		10	-
	89.191.032	32	A	NBR		10	-
	89.191.040	40	A	NBR		10	-
	89.191.050	50	A	NBR		10	-
	89.191.063	63	A	NBR		10	-
	89.191.090	90	B	NBR		10	-
	89.191.110	110	B	NBR		10	-
	89.191.160	160	B	NBR		10	-
	89.193.020	20	C	EPDM		10	-
	89.193.025	25	C	EPDM		10	-
	89.193.032	32	C	EPDM		10	-
	89.193.040	40	C	EPDM		10	-
	89.193.050	50	C	EPDM		10	-
	89.193.063	63	C	EPDM		10	-
	89.193.090	90	D	EPDM		10	-
89.193.110	110	D	EPDM		10	-	
89.193.160	160	D	EPDM		10	-	

Těsnění pro příruby	Objednáací číslo	Ø	Typ	Materiál		Balení A kusy	Balení B kusy
	89.118.110	110	A	NBR		10	-
	89.118.160	160	A	NBR		10	-
	89.119.110	110	B	EPDM		10	-
	89.119.160	160	B	EPDM		10	-

Mosazný kulový kohout s vnitřními závity	Objednací číslo	Ø		PN		Balení A kusy	Balení B kusy
	89.821.048	1/2"		25 bar		1	-
	89.821.068	3/4"		25 bar		1	-
	89.821.088	1"		25 bar		1	-
	89.821.108	1.1/4"		25 bar		1	-
	89.821.128	1.1/2"		25 bar		1	-
	89.821.168	2"		25 bar		1	-
	89.821.248	3"		25 bar		1	-

Nerezový kulový kohout s vnitřním a vnějším závitem	Objednací číslo	Ø		PN		Balení A kusy	Balení B kusy
	89.824.048	1/2"		25 bar		1	-
	89.824.068	3/4"		25 bar		1	-
	89.824.088	1"		25 bar		1	-
	89.824.108	1.1/4"		25 bar		1	-
	89.824.128	1.1/2"		25 bar		1	-
	89.824.168	2"		25 bar		1	-
	89.824.248	3"		25 bar		1	-

Ventil pro odvod kondenzátu	Objednací číslo	Ø		PN		Balení A kusy	Balení B kusy
	89.823.048	1/2"		25 bar		10	-
	89.823.068	3/4"		25 bar		10	-

Nerezový kulový kohout s vnitřními závity	Objednací číslo	Ø		PN		Balení A kusy	Balení B kusy
	89.820.048	1/2"		60 bar		1	-
	89.820.068	3/4"		60 bar		1	-
	89.820.088	1"		60 bar		1	-
	89.820.108	1.1/4"		60 bar		1	-
	89.820.128	1.1/2"		60 bar		1	-
	89.820.168	2"		60 bar		1	-

Motýlový ventil	Objednací číslo	Ø		PN		Balení A kusy	Balení B kusy
	89.826.328	DN100 4"		16		1	-
	89.826.408	DN140 5"		16		-	-
	89.826.488	DN150 6"		16		1	-

Objímka s vrutem	Objednáací číslo	Ø				Balení A kusy	Balení B kusy
	89.800.020	20			-	10	-
	89.800.025	25			-	10	-
	89.800.032	32			-	10	-
	89.800.040	40			-	10	-
	89.800.050	50			-	10	-
	89.800.063	63			-	10	-
	89.800.090	90			-	5	-
	89.800.110	110			-	5	-
	89.800.140	140			-	5	-
	89.800.160	160			-	5	-

Objímka	Objednáací číslo	Ø				Balení A kusy	Balení B kusy
	89.801.020	20			-	10	-
	89.801.025	25			-	10	-
	89.801.032	32			-	10	-
	89.801.040	40			-	10	-
	89.801.050	50			-	10	-
	89.801.063	63			-	10	-
	89.801.090	90			-	5	-
	89.801.110	110			-	5	-
	89.801.140	140			-	5	-
	89.801.160	160			-	5	-

Nosná konzole	Objednáací číslo	Ø				Balení A kusy	Balení B kusy
	89.871.300	300mm				5	-
	89.871.500	500mm				5	-

Šroub s jezdcem pro nosník	Objednáací číslo	Ø				Balení A kusy	Balení B kusy
	89.872.001	x89.871.300				10	-
	89.872.002	x89.871.500				10	-

Závitová tyč	Objednáací číslo	Ø				Balení A kusy	Balení B kusy
	89.873.020	M8x20				10	-
	89.873.030	M8x30				10	-

Nosná svěrka	Objednáací číslo	Ø				Balení A kusy	Balení B kusy
	89.874.000	-				10	-

Šroub samozávrtný	Objednáací číslo	Ø				Balení A kusy	Balení B kusy
	89.875.508	M8				10	-

Bezpečnostní rychlospojka typ M,
s vnějším závitem

Objednací číslo	Ø	Typ	PN	Balení A kusy	Balení B kusy
89.750.028	1/4"		20 bar	10	100
89.750.038	3/8"		20 bar	10	100
89.750.048	1/2"		20 bar	10	100



Bezpečnostní rychlospojka typ F,
s vnitřním závitem

Objednací číslo	Ø	Typ	PN	Balení A kusy	Balení B kusy
89.751.038	3/8"		20 bar	10	100
89.751.048	1/2"		20 bar	10	100



Bezpečnostní rychlospojka typ P,
s hadičníkem

Objednací číslo	Ø	Typ	PN	Balení A kusy	Balení B kusy
89.752.608	8		20 bar	10	100
89.752.610	10		20 bar	10	100
89.752.612	12		20 bar	10	100



Průtok stlačeného vzduchu

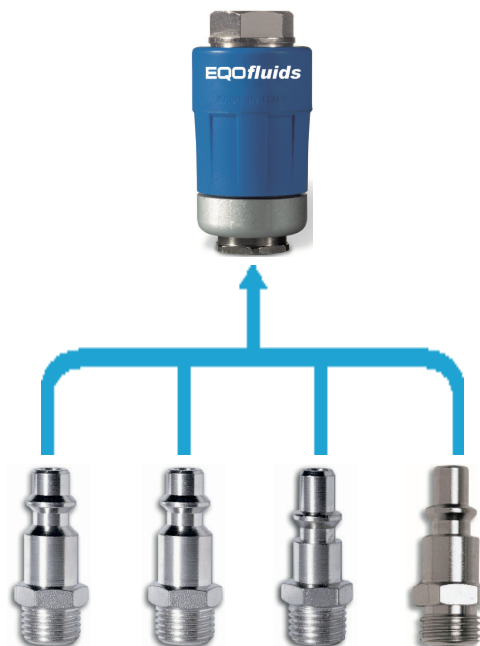
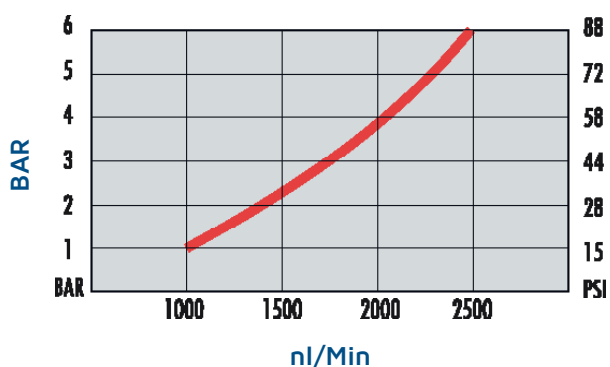

Vsuvky USA			Objednáací číslo	ø	Obr.	PN	Balení A kusy	Balení B kusy
 H B E	89.760.028	1/4"	H	20 bar		10	100	
	89.760.038	3/8"	H	20 bar		10	100	
	89.760.048	1/2"	H	20 bar		10	100	
	89.761.028	1/4"	B	20 bar		10	100	
	89.761.038	3/8"	B	20 bar		10	100	
	89.761.048	1/2"	B	20 bar		10	100	
	89.762.608	8	E	20 bar		10	100	
	89.762.610	10	E	20 bar		10	100	
Vsuvky Evropa			Objednáací číslo	ø	Obr.	PN	Balení A kusy	Balení B kusy
 H B E	89.770.028	1/4"	H	20 bar		10	100	
	89.770.038	3/8"	H	20 bar		10	100	
	89.770.048	1/2"	H	20 bar		10	100	
	89.771.028	1/4"	B	20 bar		10	100	
	89.771.038	3/8"	B	20 bar		10	100	
	89.771.048	1/2"	B	20 bar		10	100	
	89.772.608	8	E	20 bar		10	100	
	89.772.610	10	E	20 bar		10	100	
Vsuvky typ CH			Objednáací číslo	ø	Obr.	PN	Balení A kusy	Balení B kusy
 H B E	89.780.028	1/4"	H	20 bar		10	100	
	89.780.038	3/8"	H	20 bar		10	100	
	89.780.048	1/2"	H	20 bar		10	100	
	89.781.028	1/4"	B	20 bar		10	100	
	89.781.038	3/8"	B	20 bar		10	100	
	89.781.048	1/2"	B	20 bar		10	100	
	89.782.608	8	E	20 bar		10	100	
	89.782.610	10	E	20 bar		10	100	
Vsuvky typ I			Objednáací číslo	ø	Obr.	PN	Balení A kusy	Balení B kusy
 H B E	89.790.028	1/4"	H	20 bar		10	100	
	89.790.038	3/8"	H	20 bar		10	100	
	89.790.048	1/2"	H	20 bar		10	100	
	89.791.028	1/4"	B	20 bar		10	100	
	89.791.038	3/8"	B	20 bar		10	100	
	89.791.048	1/2"	B	20 bar		10	100	
	89.792.608	8	E	20 bar		10	100	
	89.792.610	10	E	20 bar		10	100	

Řezák trubek	Objednáací číslo	Ø	Typ			Balení A kusy	Balení B kusy
--------------	------------------	---	-----	--	--	---------------	---------------



89.501.020.063	20 - 63		-			-	-
----------------	---------	--	---	--	--	---	---

Odhrotování	Objednáací číslo	Ø	Typ	PN		Balení A kusy	Balení B kusy
-------------	------------------	---	-----	----	--	---------------	---------------



89.511.020.050	20 - 50	A					-
89.512.020.050	20 - 50	A vrtací					
89.512.001	-	B					

Vrtací nástroj	Objednáací číslo	Ø	Závit	Odbočky		Balení A kusy	Balení B kusy
----------------	------------------	---	-------	---------	--	---------------	---------------

89.521.014	14	1/2"	25.32				-
89.521.019	19	3/4"	40.50.63				-
89.521.024	24	1"	-				
89.521.048	48	2"	-				
89.521.079	79	3"	-				

Nástroj pro označení trubek	Objednáací číslo	Ø	Typ	PN		Balení A kusy	Balení B kusy
-----------------------------	------------------	---	-----	----	--	---------------	---------------

89.531				-			-
--------	--	--	--	---	--	--	---

Předváděcí kufr	Objednáací číslo	Ø	Typ	PN		Balení A kusy	Balení B kusy
-----------------	------------------	---	-----	----	--	---------------	---------------



PR.010.001	20-90	A	-			-	-
PR.010.002	110-160	B	-			-	-

